

EN USER GUIDE MANUAL

Refrigerator

Ref : DFA179NXA

De Dietrich 



DEAR CUSTOMER,

Discovering De Dietrich products is experiencing unique emotions that only valuable objects can produce.

The appeal is immediate at first glance. The quality of the design is illustrated by the timeless aesthetics and the meticulous finishes that make each object elegant and refined in perfect harmony with each other.

Then comes the urge to touch. De Dietrich design is based on robust and prestigious materials; authenticity is favored.

By combining the most advanced technology with noble materials, De Dietrich ensures the creation of high quality products at the service of the culinary art, a passion shared by all kitchen lovers.

We wish you a lot of satisfaction in using this new appliance and will be happy to receive your suggestions and answer your questions. We invite you to express them to our customer service or on our website.

We invite you to register your product on www.de-dietrich.com to enjoy the benefits of the brand.

Thank you for your confidence.

De Dietrich 

Find out all the information on the brand on:

www.de-dietrich.com



Important: Before switching on your appliance, please read this user guide carefully in order to familiarise yourself more quickly with its operation.



This appliance complies with the European directives.



SAFETY GUIDELINES

For your safety and in order to use your appliance correctly, carefully read these instructions (including the warnings and useful advice), before installation and first use.

To avoid damaging the appliance and unnecessary injury, it is important that the persons who use the appliance fully understand how it works and the safety instructions.

Always keep these instructions close to the appliance so that they can accompany it in the event of resale or a change of house. In this way, the appliance will continue to function optimally and any risk of injury will be avoided.

The manufacturer shall not be held liable in the event of misuse of the appliance.

GENERAL SAFETY AND WARNINGS

This appliance is exclusively intended for domestic use in private households. It may only be used in a roofed, enclosed and heated environment such as a kitchen or any other room fulfilling these conditions. Its use on shared or professional premises such as in an office or workshop break room, a camp site building, or a hotel, etc., does not comply with the use defined by the manufacturer.



WARNING! Keep your appliance away from any source of flame during installation, servicing and use. The symbol in the margin which is found on the rear of your appliance, means that there are inflammable materials in this area.

The refrigerating and insulating agents used in this appliance contain inflammable gases.

When transporting, installing and servicing the appliance, make sure that none of the components of the cooling circuit are damaged. If the cooling circuit is damaged:

- ✓ Avoid naked flames and all sources of inflammation.
- ✓ Ventilate the room in which the appliance is installed.



Installation safety

- Your appliance must be installed and, if necessary, secured and used in accordance with the instructions in this manual in order to avoid any risks due to poor installation.
- Maintain clear of obstruction ventilation openings in the appliance enclosure or in the built-in structure.
- It is dangerous to change the composition of this model in any way whatsoever.
- Ensure that the power cord is not trapped or damaged when you position your appliance.
- Any damage to the power cord may result in a short circuit and/or electrocution.
- If the power cord is damaged, it should be replaced by the manufacturer, its after-sales service department or a similarly qualified person, so as to avoid danger.
- Do not place multiple plugs or portable power supply units behind the appliance.
- For models fitted with a water dispenser or an ice compartment, only fill or connect using a supply of drinking water.



Safety of vulnerable persons

- This appliance may be used by children aged 8 years or more and by people with physical, sensual or mental deficits and lacking experience or knowledge of the device provided that they are correctly supervised or have been provided with instructions regarding the safe use of the appliance and provided that the risks present have been fully understood.
- Children must not play with the appliance.
- Children must not clean and maintain the appliance without supervision.
- Children aged 3 to 8 are allowed to load and unload refrigeration appliances.
- Keep all the packaging materials out of the reach of children, as they can cause suffocation.



Safety of use

- Do not damage the refrigerating circuit.
- Do not use any mechanical or other means, other than those recommended by the manufacturer, to speed up the defrosting process.
- Do not use any electric appliances inside the compartment for food, unless they are of a type recommended by the manufacturer.
- Do not store any explosive substances, such as aerosols containing inflammable propellant gases, inside the appliance.



Food safety

To avoid contaminating food, follow the instructions below:

- Leaving the door open for long periods of time may significantly raise the temperature in the appliance compartments.
- Regularly clean any surfaces that may come into contact with food and accessible drain systems.
- Clean water containers if they have not been used for 48 hours. Properly rinse the water distribution system connected to a fresh water network if no water has been drawn off for five days.
- Store raw meat and fish in the appropriate refrigerator compartments so that the latter products are not in contact with other food and do not drip onto other food.
- The "two star" compartments for frozen foods are suitable for storing food that is already frozen, for storing or making ice cream and ice cubes.
- The "one, two and three star" compartments are not suitable for freezing fresh foods.
- If the refrigerator remains empty for an extended period of time, switch it off, defrost it, clean it, dry it and leave the door open to prevent any mould from forming inside the appliance.

DISPOSAL



This symbol indicates that this product should not be treated as household waste.

Only dispose of the appliance in certified collection centres.

Your appliance contains a large amount of recyclable material. It is marked with this label to indicate the used appliances must be disposed of in certified collection points.

Contact your town hall or your retailer for the used appliance collection points closest to your home. This way, the appliance recycling organised by your manufacturer will be done under the best possible conditions, in compliance with European Directive on Waste Electrical and Electronic Equipment.

This appliance's packing materials are also recyclable. Help recycle it and protect the environment by dropping it off in the municipal receptacles provided for this purpose.

In accordance with the most recent legislative provisions applying to the protection and respect for the environment, your appliance does not contain any CFCs, but a refrigerant called R600a. The exact type of coolant gas used in your appliance is clearly shown on the ID plate inside the fridge part of your appliance, at the foot of the left-hand side panel. R600a is a non-polluting gas that does not harm the ozone layer and hardly contributes to the greenhouse effect at all.

Used appliances must be immediately made unusable.

Disconnect the power cord and cut it as close to the appliance as possible. Inhibit the closing mechanism of the door or, even better, detach the door, so that children or pets cannot remain enclosed inside the appliance when playing.

DESIGN

Layout and presentation of your appliance

- This refrigeration appliance is not intended to be used as a built-in appliance
- Your appliance was designed and tested to optimise its energy use.
- The proposed layout represents the ideal solution for achieving ideal energy consumption and optimum food storage.

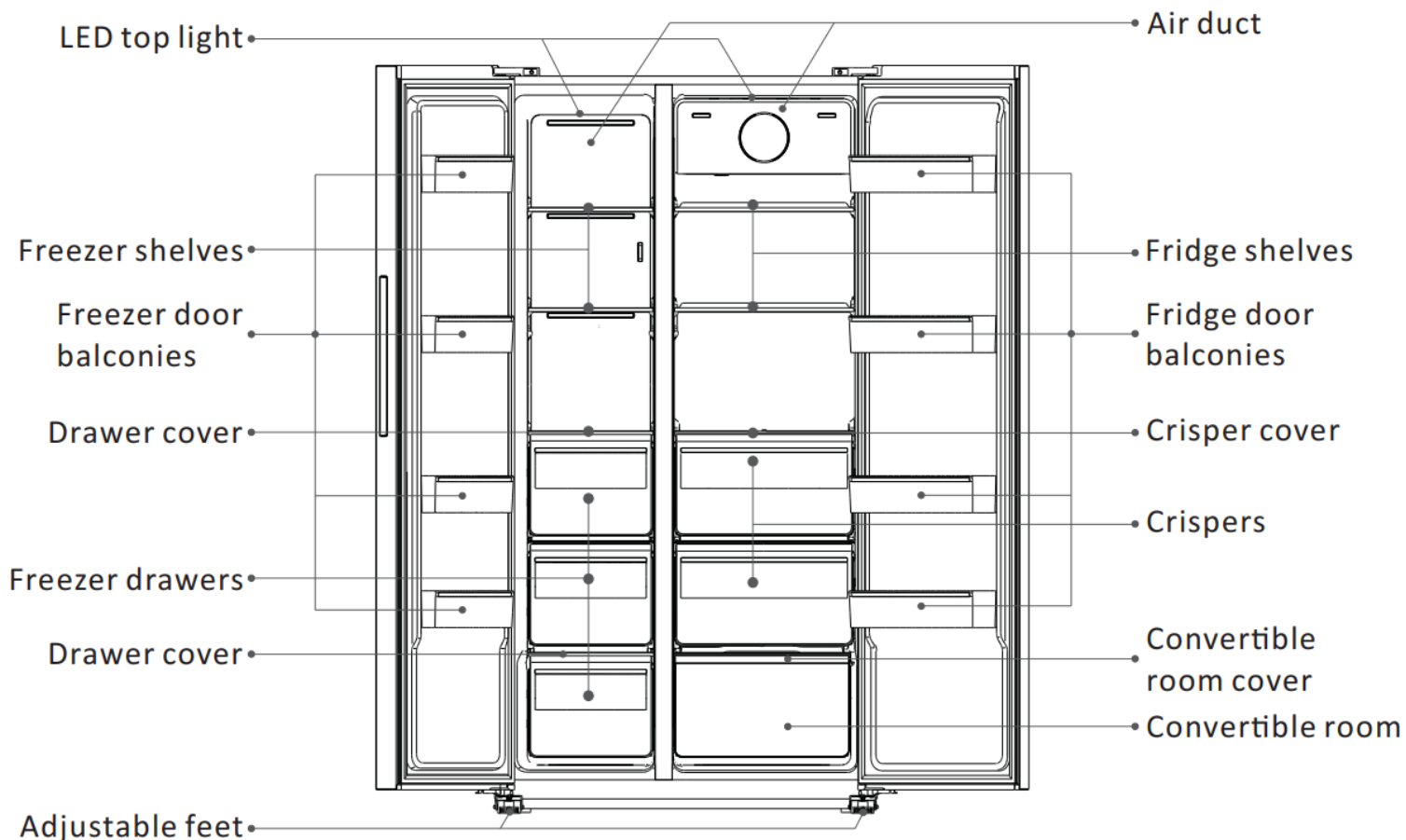

*This illustration is only for information guidance only, please check your appliance for further details.

You can only keep your food in good condition and optimise your energy consumption by following the instructions in this installation and user guide.

Energy-saving measures

In order to reduce the power consumption of your appliance:

- Install it in a suitable location (see "Installing your appliance").
- Leave the doors open for the shortest time possible.
- Never put hot food in the fridge or the freezer, and in particular soups and other preparations that release a lot of steam.
- Regularly check the door seals and make sure that the doors can be closed properly. If this is not the case, contact after-sales service.
- Do not adjust the temperature too low.

Storing food

Here are some rules you should follow:

- Clean the refrigerator part at least once a month (see Care and cleaning)
- Keep home-made food in the refrigerator after first taking care to leave it to cool.
- Make sure that your appliance is set to the recommended temperatures shown below. The temperatures for every compartment are recommended to optimise storing food and avoid any waste.

Area	Type of compartment	Recommended temperature
Fresh food compartments	Fresh food compartment (refrigerator)	+4°C
Frozen food compartments	0 star compartment (depending on model)	0°C
	1 star compartment (depending on model)	-6°C
	2 star compartment (depending on model)	-12°C
	3 star compartment (depending on model)	-18°C
	4 star freezer drawers/shelves (depending on model)	-18°C

- Place the food in the locations recommended in the tables below.

Fresh food compartments

Refrigerator compartments	Type of food
Refrigerator door and door racks	Jams, drinks, eggs, condiments. Do not place perishable fresh food in these areas
Crisper	Lettuce, fruit, vegetables, herbs Do not put bananas, onions, potatoes or garlic in the refrigerator.
Lower shelf	Raw meat, fish, highly perishable food.
Intermediate shelf	Dairy products
Top shelf	Cold cuts, prepared meals, meals to reheat

Frozen food compartments (compartments available depending on model)

Freezer compartments	Logos & Markings	Type of food
0 star compartment		To store sorbet for a few hours and make ice cubes. This compartment is not suitable for freezing fresh food.
1 star compartment	✱	To store frozen products for a few hours and make ice cubes. This compartment is not suitable for freezing fresh food.
2 star compartment	✱ ✱	To store frozen products for a few days, make ice cream and ice cubes. This compartment is not suitable for freezing fresh food.
3 star compartment	✱ ✱ ✱	To store frozen products for a few weeks/months and make ice cubes. This compartment is not suitable for freezing fresh food.
4 star freezer drawers/shelves		To freeze food and store: <ul style="list-style-type: none"> - Meat, fish (lower drawer/shelf). - Vegetables, chips (intermediate drawer/shelf). - Ice cream, fruit, ready-made dishes (upper drawer/shelf)

INSTALLATION

Care before installation

Before installing the appliance and connecting it to the power, wash the interior and all internal accessories with lukewarm water and some neutral soap so as to remove the typical smell of a brand new product, then dry thoroughly.

① **Never use detergents or abrasive cleaners, they will damage the inside coating.**

When using the appliance for the first time or after a period of non-use, before putting the food in the compartment let the appliance run at least two hours on the higher settings.

Location

 **Warning! Never expose the appliance to a naked flame.**

- Install the appliance in a dry and well ventilated place.
- The appliance should be located far from heat sources like radiators, boilers, sunlight, etc.
- Your appliance is designed to function optimally at a given ambient temperature. In this case, it is said to be designed for a particular "climate class". The climate class is clearly shown on the ID plate (see the "Contact" chapter). The refrigerator may not maintain satisfactory inside temperatures if it operates outside of the temperature limits set for the "climate class" it is designed for. Ensure that the chosen location is compliant with these temperature limits:

Class	Ambient temperature
SN	This refrigeration appliance is designed for use at ambient temperatures between 10°C and 32°C
SN-ST	This refrigeration appliance is designed for use at ambient temperatures between 10°C and 38°C
SN-T	This refrigeration appliance is designed for use at ambient temperatures between 10°C and 43°C
N	This refrigeration appliance is designed for use at ambient temperatures between 16°C and 32°C
ST	This refrigeration appliance is designed for use at ambient temperatures between 16°C and 38°C
T	This refrigeration appliance is designed for use at ambient temperatures between 16°C and 43°C

- Based on the above, avoid locating your appliance on balconies, verandas, terraces, in garages, etc. Excessively high temperature in summer and excessively low temperatures in winter can prevent it from functioning properly and therefore properly conserving food.
 - Appliance levelling is achieved by adjusting one or more adjustable feet located under the unit (refer to the "Levelling the appliance" section).
- ① If your appliance is fitted with casters, then remember that they should only be used for short movements. Do not move the appliance over long distances on its casters.

Space requirements

- Select a location that is not directly exposed to sunlight.
- Select a location that is large enough for the refrigerator doors to open easily.
- Allow a safe distance to the right, left, back and top of the unit when installing. This will optimize the performance of the product, reduce your energy consumption and therefore limit your electricity bill (see drawing below).
- Make sure that the air can circulate freely at the back of the unit.
- Keep at least 50mm gap between the wall and the two sides. Same for the wall and the back.

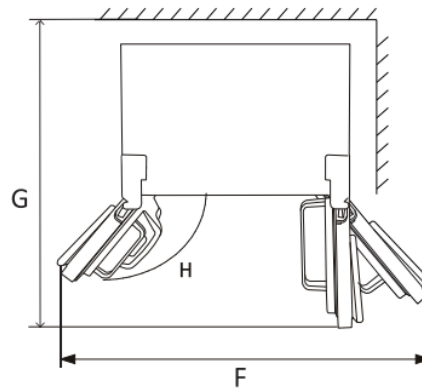
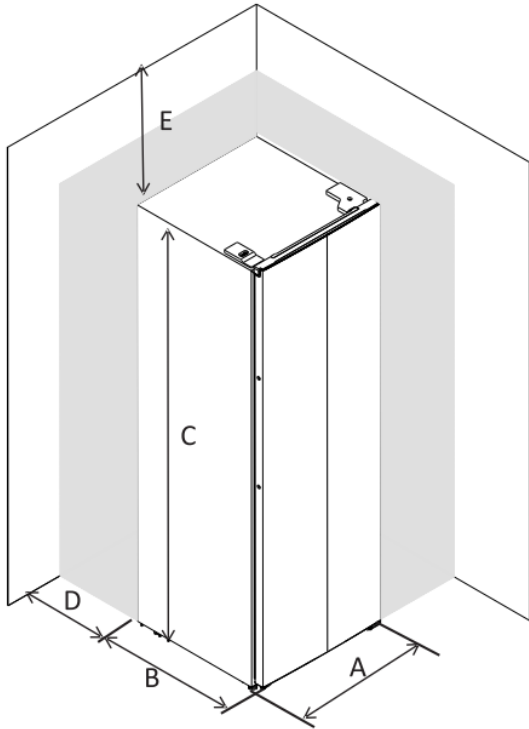

A	905
B	730
C	1770
D	min=50
E	min=50
F	1565
G	1220
H	140°

Dimensions

(Width*Depth*Height) 900mm×730mm×1770mm

i Please note that this appliance is not intended to be built-in.

Levelling the appliance

Choose a place to install the refrigerator on a flat surface.

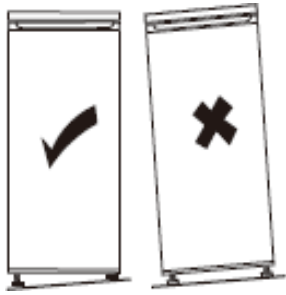

If the appliance is not level, the doors will not be correctly aligned and compartment sealing will not be ensured.

To level the appliance laterally, adjust the two adjustable feet on the front of the product.

Once the appliance is installed, ensure that it is slightly inclined rearwards. In this way, it will be easier to close the door. If necessary, adjust the setting of the adjustable feet.

Procedure for adjusting the feet at the front of the product

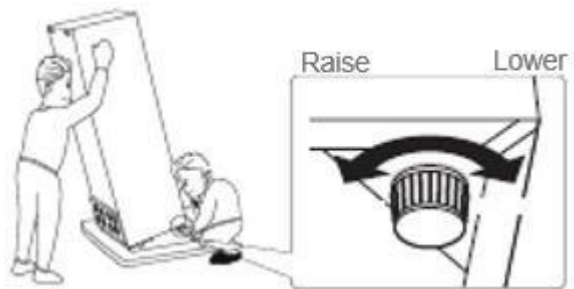

Electrical connections



Warning! It must be possible to unplug the appliance from the mains power, so the plug must remain easy to access after installation.

- The electric connections must meet the applicable standards and be capable of withstanding the maximum power shown on the ID plate.
- The power plug must be easily accessible and out of the reach of children.
- For your safety this appliance must be earthed. If the power plug is not earthed, consult a qualified electrician to connect your appliance in line with applicable regulations.
- Do not use extensions, adapters or multiple plugs.
- Do not place multiple plugs or portable power supply units behind the appliance.

The manufacturer declines all liability if the above-mentioned safety precautions are not complied with. **If in doubt, refer to your reseller.**

USE & TIPS

Using the control panel

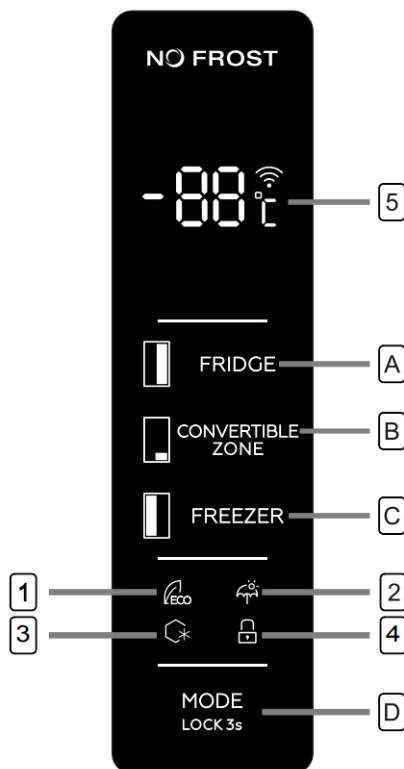

Buttons

- A** Press to adjust temperature of fridge compartment (right side) from 2°C to 8°C
- B** Press to adjust temperature of convertible zone from 5°C to -3°C
- C** Press to adjust temperature of freezer compartment (left side) from -14°C to -22°C
- D** Press to select running mode from **ECO**, **HOLIDAY**, **SUPER FREEZING** and **USER'S SETTING** (no symbol in display).

Press 3 sec button and hold for 3 seconds to lock other three buttons.

Press it and hold for 3 seconds to unlock other three buttons.

Display

1 **ECO** mode

Press mode to choose ECO Mode, ECO icon keeps bright after 5 sec flashing.

Temperature fix 6 C in fridge compartment and -16 C in freezer compartment under ECO Mode, "Freezer" & "Fridge" button in vain while ECO icon will flash three times in alarm.

The temperature of convertible compartment can be adjusted freely by operating the convertible zone temp. setting.

Exit **ECO** Mode:

Choose mode, exit ECO Mode after 5 sec, entering the selected mode.

2 HOLIDAY mode

Press mode to choose Holiday Mode, the icon keeps bright after 5 sec flashing, entering holiday mode. Temperature fix 17 C in fridge compartment, "fridge" button in vain, while holiday icon will flash three times in alarm.

Temperature of freezer compartment and convertible compartment can be adjusted freely. Exit Holiday Mode:

Choose mode, exit Holiday Mode after 5 sec, entering the selected mode.

3 SUPER FREEZING mode

Choose mode, the icon keeps bright after 5 sec flashing, entering Freezing Mode. Freezing mode:

Temperature fix -25°C in freezing compartment, "freezer" button in vain, while freezing icon will flash three times in alarm.

Temperature of fridge compartment and convertible compartment can be adjusted freely.

Exit Freezing Mode:

meeting below conditions.

-manually exit Freezing Mode.

-freezing period more than 50 hours.

4 LOCK, the symbol will light on if buttons are locked.

5 TEMPERATURE display, display the setting temperature of fridge zone/ convertible zone/ freezer zone.

Door open alarm

When any door is left open or not closed completely for about 60 seconds, the appliance will sound an alarm. Close the fridge door then the alarm will stop.

If the door is not well closed, then the alarm will sound every 30 seconds until the doors are well closed.

If doors are open for 10 continuous minutes without closing, the internal LED light would be turned off automatically.

Child safety lock

This function is designed to prevent children from operating the appliance.

To activate the function, press and hold LOCK 3s for about 3 seconds. The lock indicator light  will illuminate indicating the safety lock function is activated.

To deactivate the function, press and hold LOCK 3s for about 3 seconds. The unlock indicator light  will illuminate indicating the safety lock function is deactivated.

Daily Use

Your refrigerator compartment is equipped with shelves, door racks and drawers with various logos to help you store your food in the right place.

Using the shelves

The walls of the refrigerator are equipped with a series of runners so that the shelves can be positioned as desired.

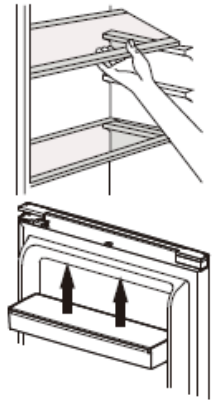

Positioning the small door trays

The small door trays can be removed to assist cleaning. To do this, progressively pull the door rack in the direction indicated by the arrows until you can remove it completely. After cleaning it, replace it in the desired location.

Hints & Tips

The refrigerator is a domestic appliance suited to short-term conservation of food products like fruit, vegetables, drinks, etc.

- Do not use it as a specialised appliance for storing products that require storage in line with strict temperature rules, like medicines, etc.
- Cooked foods must be cooled to ambient temperature before they are placed in the refrigerator.
- We recommend placing food in sealed containers before storing them in the fridge.
- Never place food right next to the air outlet as this could impede the airflow and freeze the food.
- Never place volatile, inflammable or explosive liquids like solvents, alcohol, acetone or petrol in the fridge. There is an explosion hazard.
- Never leave the door open longer than necessary.

Hints for refrigeration

- Meat (all types) must be wrapped in sealed polyethylene bags and placed on the glass shelf above the crisper.
- For safety, store in this way only one or two days at the most.
- Cooked foods, cold dishes, etc.: these should be covered and may be placed on any shelf.
- Fruit and vegetables: these should be thoroughly cleaned and placed in the special drawer provided.
- Butter and cheese should be placed in special sealed containers, wrapped in aluminium foil or placed in a sealed bag.
- Milk bottles should be capped and stored in the bottle rack in the door.
- To save energy, all of the door shelves and glass shelves should be fitted in their designed location.

Freezing tips

To help you optimise the freezing process, here are some important tips:

- The maximum amount of food that you can freeze every 24 hours can be found on the ID plate.
- The freezing process takes 24 hours. Do not add any more food to freeze during this time.
- Only freeze good quality, fresh and properly washed food.
- Prepare food in small portions to enable it to be rapidly and completely frozen and to make

it possible to subsequently thaw only the quantity required.

- Wrap up the food in aluminium foil or polyethylene food wraps which are airtight.
- Do not allow fresh, unfrozen food to touch the food which is already frozen to avoid raising their temperature.
- Iced products, if consumed immediately after removal from the freezer compartment, may cause frost burns to the skin.
- We recommend labelling and dating each frozen package.
- To obtain ice cubes faster, we recommend placing the ice cube trays in the top drawer.

Thawing food

Before eating, frozen or deep frozen food may be thawed in the refrigerator compartment or at ambient temperature, depending on the time available.

Some food may also be cooked directly when taken out of the freezer, while it is still frozen. In this case, cooking will take longer.

Important ! In the event of accidental thawing, caused for example by a power break, quickly eat the thawed food. Never refreeze thawed food.

 **Warning! No thawed food may be replaced in the freezer. Place it in the refrigerator then eat it quickly.**

Refreezing a thawed product encourages the spread of bacteria. This may become a health hazard if the bacteria that spreads are pathogens, as these may cause more or less serious food poisoning depending on the type of bacteria involved. If any doubt, cook the food involved.

Hints for the storage of frozen food

To guarantee optimum performance, comply with the following instructions:

- Ensure that frozen food has been stored correctly by the food retailer.
- Ensure that frozen food is quickly carried from the retailer to your freezer.
- Do not open the door too often or avoid leaving the door open longer than necessary.
- Once thawed, food will deteriorate rapidly and should never be refrozen.

Do not exceed the storage states shown on the food

CARE & CLEANING



Warning! Always unplug your appliance before any maintenance work. Never pull on the power cord, but only on the plug itself.

Cleaning

For hygiene reasons, regularly clean the appliance (sidewalls and interior and exterior accessories).

Important! Ethereal oils and organic solvents can damage plastic parts, e.g. lemon juice, butyric acid or acetic acid.

- Do not allow such substances to come into contact with appliance parts.
- Do not use any abrasive cleansers.
- Remove food from the appliance. Store it in a cool place and keep well covered.
- Clean the appliance and the interior accessories with a cloth and lukewarm water with a diluted white vinegar or bicarbonate of soda solution. Do not wash the accessories in a dishwasher.
- After cleaning them, rinse surfaces with clear water and dry them.
- After everything is dry, plug the appliance back into the plug.
- Make sure that no water enters the lamp housing and other electrical components.
- Clean the condenser with a brush at least twice a year. This will help you to save energy costs and increase productivity.

① **Never clean the appliance with a steam cleaner.**

Cleaning the drain

To stop the defrost water from running into the refrigerator, clean the drain at the back of the refrigerator part from time to time. To do this, use a cleaning product as shown in the diagram on the right.

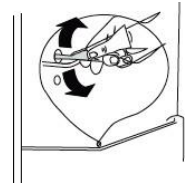

Replacing the light

The light inside the fridge uses a LED. To replace it, please contact your after sales service or an approved technician.

You will find all the information you need to contact our authorized technicians and our after-sales service in the “CONTACTS & INFORMATION” section.

Troubleshooting

If there is any anomaly during operation, check the following points before calling our approved after sales service or a qualified professional.

	Case	Explanation
Heat	Front and side of refrigerator feels warm or hot.	Pipes (refrigerant vessel) are placed beneath the surface to prevent moisture forming on it.
Door is sticky	Doors do not open easily.	When you close the door and then open again immediately, the door is not easy to open. Warm air rushes into the inside to create the pressure difference. In this case wait for a minute, then it will open easily.
Strange Sound	It sounds like water is flowing from the refrigerator	When the compressor starts to run or stops, refrigerant which makes the inside cold flowing in the pipes can make such a sound. Defrosted water can also make such a sound. (This refrigerator adopts an automatic defrosting system.)
	Cracking or clicking sounds.	Inside parts shrink and/or expand due to temperature change --- When the inside gets cold or when the door is open, such sounds can be made
	Humming or buzzing sounds	Compressor or fans for cold air circulation can make such working sound. (If the refrigerator is not level, the sound can be louder.)
Frost & Dew	Dew or frost on the wall and/or food container surface in the freezer and refrigerator compartment	Frost and/or dew can be made in the following cases; <ul style="list-style-type: none"> • High temperature and/or high humidity around the refrigerator. • When doors are open too long. • Foods with much moisture are stored uncovered or unwrapped. ※You can see the same appearance when cold water is poured in a glass cup and dew is forming on the surface of it.

	Dew on the cabinet surface.	If it is highly humid around the refrigerator, moisture in the air sticks to the surface to form dew.
The appliance does not work	The fuse has blown .	Check the fuse, replace it if necessary.
	The plug is unplugged	Connect the plug.
	The plug is defective	Electrical malfunctions must be corrected by an electrician.
Food is not cold enough	The temperature is not set correctly	Please refer to the temperature setting section
	The door has been left open for a long time	Open the door only when necessary
	A large amount of warm food has been placed in the appliance in the last 24 hours	Temporarily set the thermostat to a higher setting to cool the appliance
	The appliance is near a heat source	Please refer to the installation location section

① **Some noises may be heard during normal appliance operation (compressor operating cycle, automatic defrosting, circulation of the refrigerating gas through the appliance, etc.).**

 **If you cannot find the cause of the anomaly, call only our approved after sales service or a qualified professional.**

CONTACTS & INFORMATION

Customer Relations

For more information about our products or to contact us, please:

- Visit our website: www.de-dietrich.com

Servicing and repairs

Any repairs to your appliance must be made by a qualified professional accredited to work on the brand.

When making contact, mention the complete reference of your appliance (model, type, serial number). This information is provided on the ID plate located in your freezer compartment as shown in the following diagram:

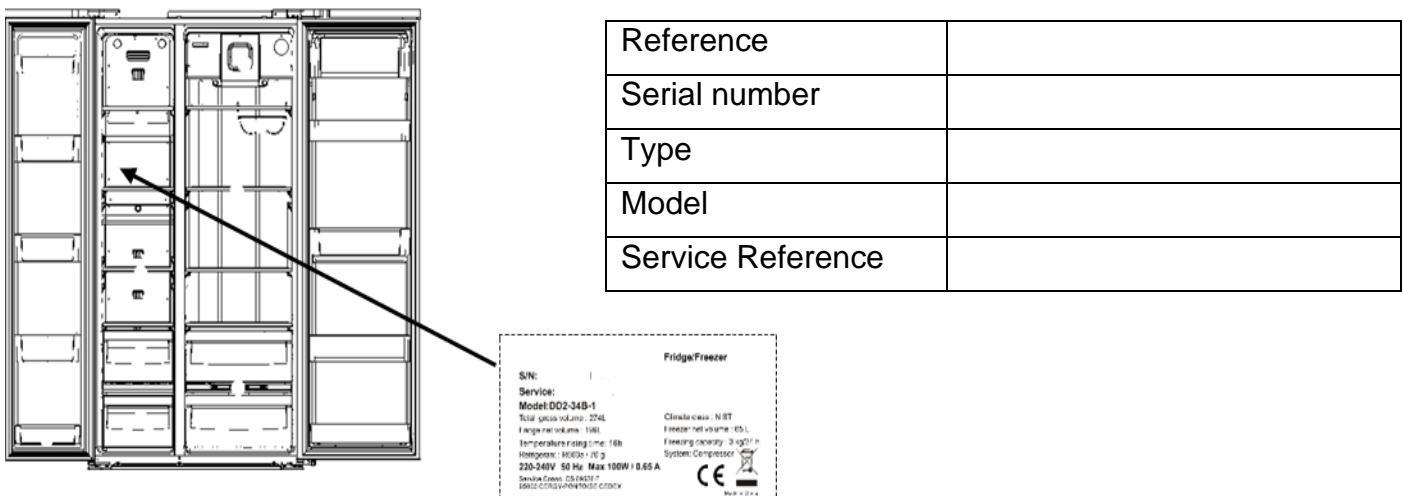

You can find a list of approved service centres on our website www.de-dietrich.com

This website also allows access to information on spare parts.

Original replacement parts

During servicing, ask for only original spare parts to be used.



The minimum length of time for making available spare parts listed in European Regulation 2019-2019-EU and accessible especially to the appliance user is 10 years under the terms set out in the above regulation.

Guarantee

Please contact your reseller to benefit from the guarantee. The manufacturer does not offer any commercial guarantee for the refrigeration appliance.